



AQMATIC

Valves & Controls

F Series Inline Flow Meters

Product Manual

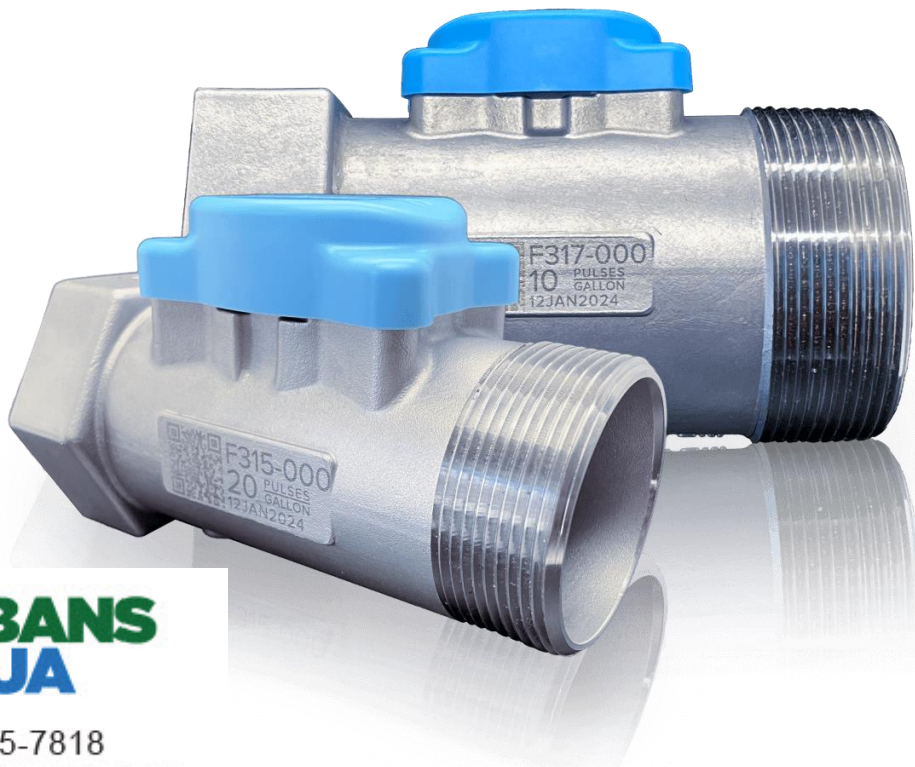

610-365-7818
info@urbansaqua.com

Specifications

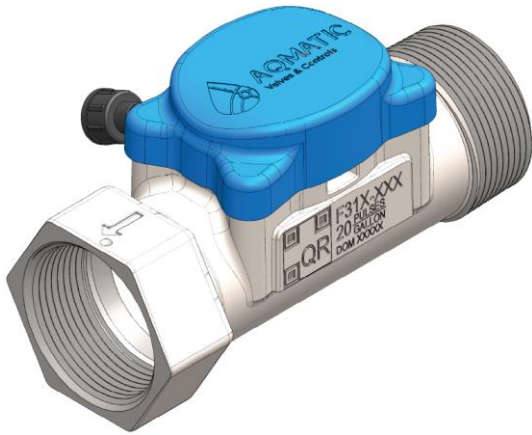





The core technology of the F Series inline flow meters is ultrasonic measurement. This eliminates internal moving parts and allows for a wider range of accuracy.

The onboard integrated control within the meter sensor module calculates a “time of flight” difference and translates that to flow indication.

Each F Series meter size utilizes the same meter sensor module.

Flow Performance

		Operating Range			
Model Number	Pipe Size	Low Flow Threshold	Typical Flow (0.1 ft/sec to 10 ft/sec)	Max Flow (16 ft/sec)	K Factor (Pulses/Gal)
 F311	1.0"	.12 gpm (.45 Lpm)	0.3 - 24.5 gpm (1.1 - 93 Lpm)	39 gpm (147 Lpm)	40 (10.57/Liter)
 F314	1.5"	.25 gpm (.95 Lpm)	0.6 - 55.1 gpm (2.3 - 209 Lpm)	88 gpm (333 Lpm)	30 (7.93/Liter)
 F315	2.0"	.45 gpm (1.7 Lpm)	1.0 - 98.0 gpm (3.8 - 371 Lpm)	156 gpm (590 Lpm)	20 (5.28/Liter)
 F317	3.0"	1.4 gpm (5.3 Lpm)	2.2 - 220.5 gpm (10.6 - 835 Lpm)	353 gpm (1336 Lpm)	10 (2.64/Liter)

Uniform Plumbing Code recommends that water velocity remain below 8 ft/sec

Max Pressure 125 psi (8.6 bar)
 Temperature Range 34°F (1°C) to 100°F (38°C)
 Operating Power 5-24VDC

Dimensions and Identification

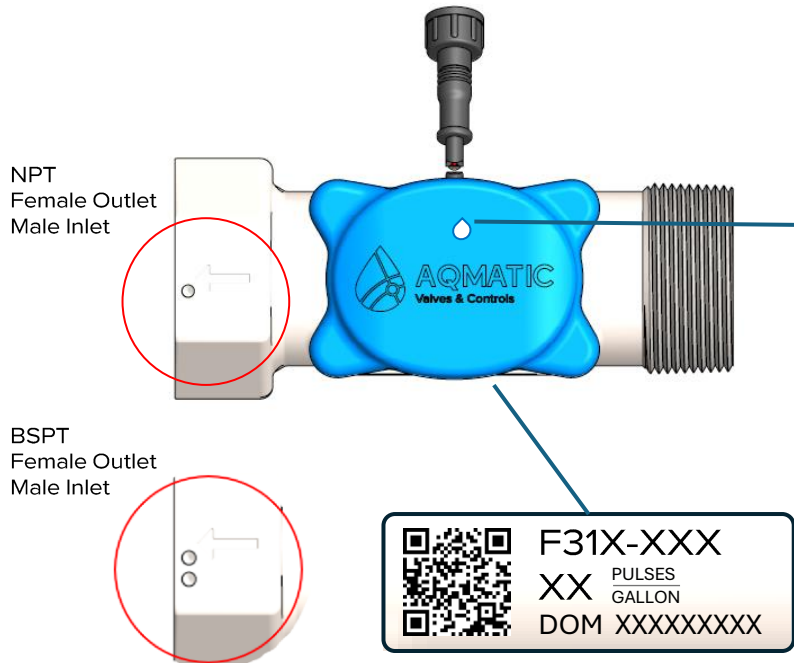

On Power Up:
LED flashes indicator of power applied and sequence to show how dip switches are set for meter size.

1 Flash	F311	1"
2 Flashes	F314	1 1/2"
3 Flashes	F315	2"
4 Flashes	F317	3"

During Operation:
LED flashes as forward flow is sensed within meter. Flashing is proportional to the rate of flow sensed.
IE: Higher flow rate produces higher frequency of flashing.

Model Number
K Factor
Date of Manufacture DDMMYYYY

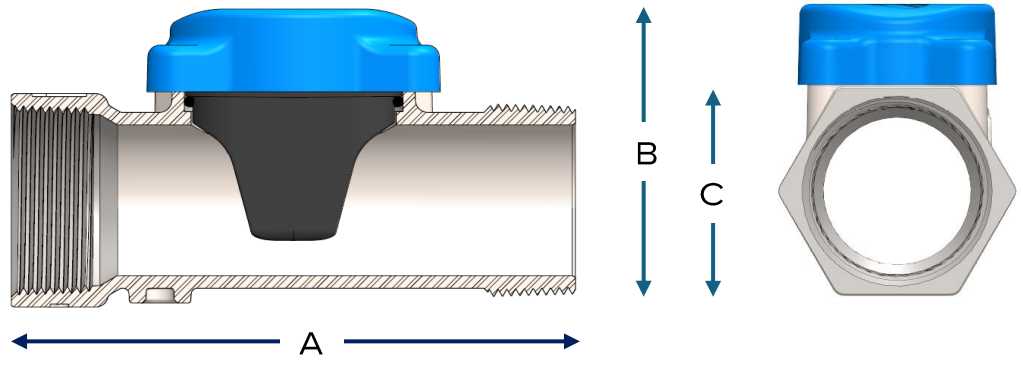

Model Number	Part Number	Pipe Size	Thread Type	Overall Length (Dim A)	Overall Height (Dim B)	Hex Width Flat to Flat (Dim C)	Weight
F311-000	53001-01	1.0"	NPT	5.6"	2.5"	1.6"	1.7 lbs
F311-001	53001-02		BSP				
F314-000	53004-01	1.5"	NPT	5.6"	3.0"	2.1"	2.0 lbs
F314-001	53004-02		BSP				
F315-000	53005-01	2.0"	NPT	5.6"	3.5"	2.6"	2.4 lbs
F315-001	53005-02		BSP				
F317-000	53007-01	3.0"	NPT	6.9"	4.5"	3.8"	4.2 lbs
F317-001	53007-02		BSP				

Application Guide

Inline flow meters are most accurate when measuring fully developed, non-turbulent flow. The F-series meters have been calibrated for measuring liquids and may not read accurately if air or other gasses are in the pipe. Orient the meter to minimize entrapped gasses around the sensors.

These recommendations are meant to guide the installation and meter orientation to promote a full pipe condition. They are also meant to provide accessibility to the meter cap for viewing flow indicator and servicing.

The meter can be installed in horizontal or vertical orientations. The meter sensor module can be aligned at any angle in the plumbing.

The operation of the F Series meter requires that the "flow hoop" remain full without air bubbles at all times. Mounting the meter vertically with flow in the downward direction may not be advisable in some installations.

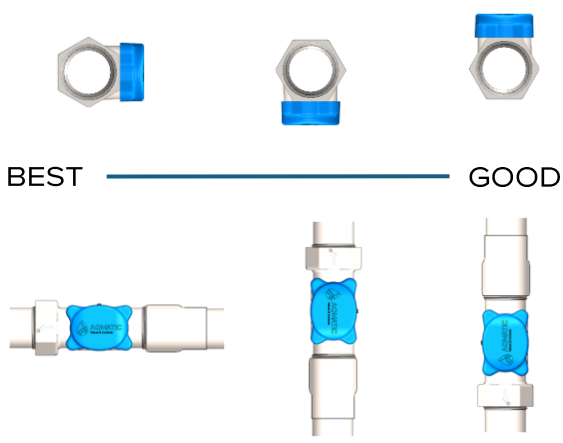

- Do not run flow meter wiring in direct proximity to power line wiring. If connecting to one of the water treatment controls listed below, insert wires into the three-pin connector as shown. If connecting to another type of control, cut off the three-pin connector and strip wires as needed.

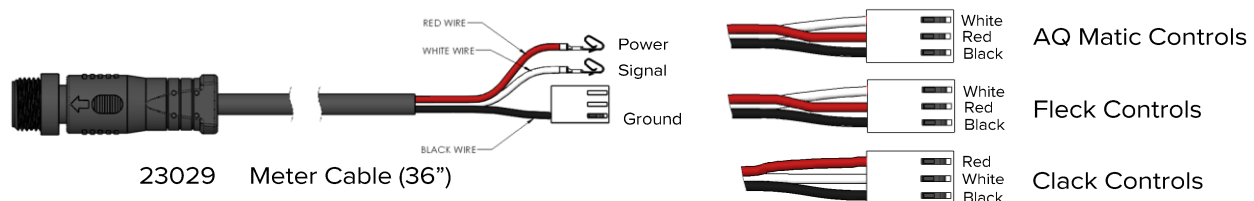

- Observe the flow direction arrow on the meter body. For **maximum** accuracy, allow 10 pipe diameters of straight pipe before the meter and 5 pipe diameters after the meter. The straight pipe recommendation is to reduce turbulence in high flow velocity conditions. For example, if installing a 1.5" meter, there should be 15.0" (1.5" x 10 = 15.0") of straight pipe before and 7.5" (1.5" x 5 = 7.5") of straight pipe after the meter for the best accuracy.
- Meter accuracy has been tested with units attached to outlet of control valves

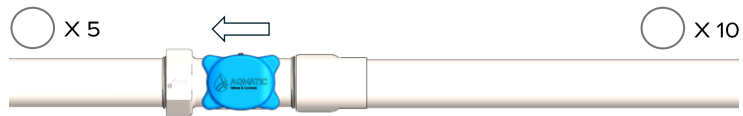

- A set of dip switches are provided on the circuit board to set the meter size. On flow meter assemblies these dip switches are preset at the factory and do not require adjustment. When replacing a flow sensor module verify the dip switch setting as shown below:

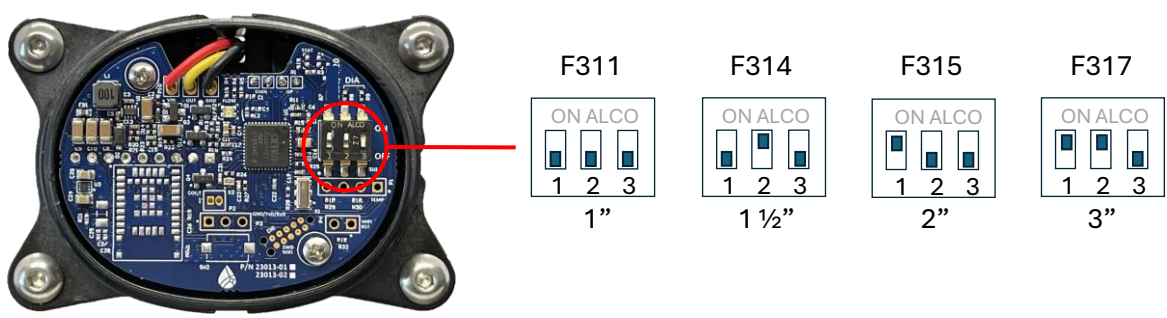

Parts and Accessories

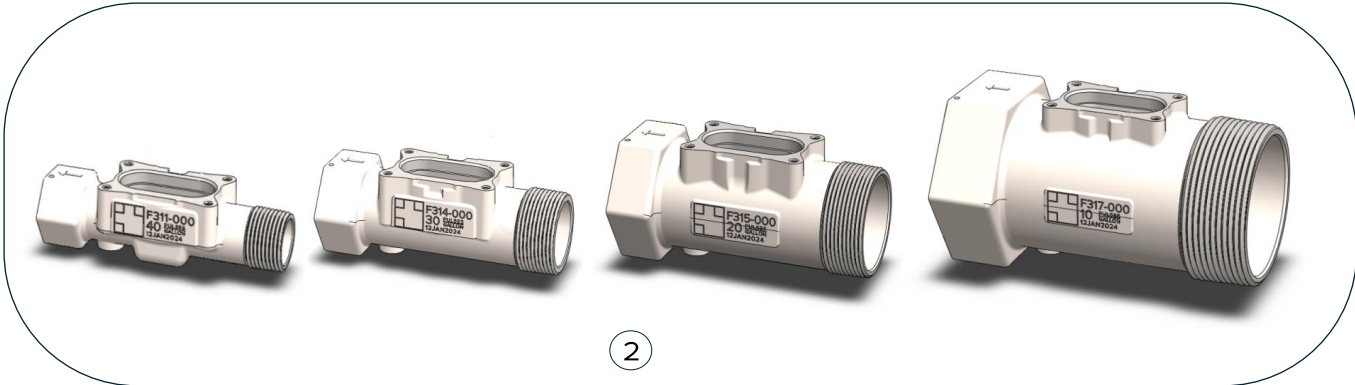
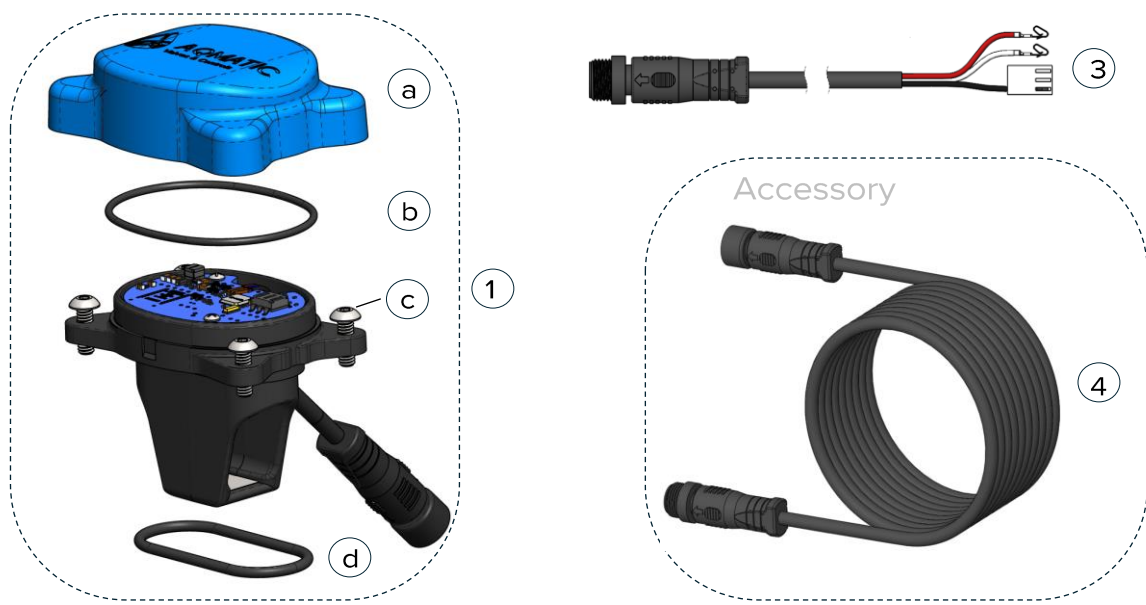

Parts & Accessories

Item Number	Description	Part Number	Quantity
1	Meter Sensor Module	53020-01	1
a	Cover, Flow Meter	23011	1
b	O-ring, Meter Cover, -033	23018	1
c	Screw, #8 - 32 x .5	23021	4
d	O-ring, Meter Body, -129	23017	1
2	Meter Body, F311, NPT	23001-01	1
	Meter Body, F311, BSP	23001-02	
	Meter Body, F314, NPT	23004-01	
	Meter Body, F314, BSP	23004-02	
	Meter Body, F315, NPT	23005-01	
	Meter Body, F315, BSP	23005-02	
	Meter Body, F317, NPT	23007-01	
	Meter Body, F317, BSP	23007-02	
3	Meter Cable (36")	23029	1
4	Meter Cable Extension (8')	23030	*

Troubleshooting Guide

Problem	Possible Cause	Solution
No signal communication	Insufficient power	When plugging in the wire harness, the LED should flash. This sequence of flashes will indicate the size meter the module is set for. If it does not, check for 5-24VDC on red (power) wire
	Cable connection not properly made	Verify that meter cable ends are properly connected at control and at threaded plug end on meter module
	Gas or air in pipe	When flow is being registered by the sensor, the LED should flash proportional to flow rate. Orient meter to minimize entrapped gas on flow sensors
	Improperly set dip switch	Check manual for dip switch setting matching the meter model and adjust as needed
	Damaged or bad circuit board	Replace flow sensor module



610-365-7818
info@urbansaqua.com



AQ Matic Valves and Controls
16605 Victor Road
New Berlin, WI 53151

Part Number 23061

Rev B JUL2024